

UP / UP+

USER MANUAL



V1.1.0

MIDIPLUS

Contents

1. Introduction	3
2. Safety Warnings and Instructions:	3
3. Getting Started.....	4
3.1 Connecting Your Up	4
3.2 Connecting Your Up+ (Extender)	4
3.3 Changing the Control Mode	4
3.4 Using the Overlays	5
4. Logic Pro X.....	5
4.1 Up / Up+ Setup.....	5
4.2 Logic Pro Setup	5
4.3 Basic Functions	8
Function / Global View Buttons.....	9
Displays	9
Assignment Buttons.....	10
V-Pots	11
Modifier Buttons.....	11
Solo and Mute Buttons	11
Automation and Group Buttons.....	12
Flip and Global Buttons	12
Multi-Purpose Jog Wheel Section.....	13
Utilities Buttons	14
Faders.....	14
Dual-Purpose Sel Buttons	14
Transport Buttons	15
5. Cubase/Nuendo.....	15
5.1 Up / Up+ Setup.....	15
5.2 Cubase/Nuendo Setup	16
5.3 Basic Functions	18
Function / Fader Bank Buttons.....	18
Displays	19
Assignment Buttons.....	19
V-Pots	20
Page Buttons.....	20
Display Buttons.....	20
Solo and Mute Buttons	21
Automation Buttons.....	21
Sends, Inst, Master and Mixer	21
Flip and Edit Buttons.....	22
Utilities Buttons	22
Multi-Purpose Jog Wheel Section.....	23
Faders.....	24
Dual-Purpose Sel Buttons	24
Transport Buttons	24
6. Ableton Live.....	25
6.1 Up / Up+ Setup.....	25
6.2 Ableton Live Setup.....	25

6.3 Basic Functions	26
The Top Row Buttons.....	27
Displays	27
Assignment Buttons.....	28
Flip and Returns Buttons.....	28
Page Buttons.....	29
Home and End Buttons	29
Solo and Mute Buttons	29
Sess/Arr. and Clip/FX Buttons	29
Browser and Detail Buttons.....	30
Draw and B.T.A. Buttons	30
Utilities Buttons	30
Modifier Buttons.....	31
Multi-Purpose Jog Wheel Section.....	31
Faders.....	32
Dual-Purpose Sel Buttons	32
Transport Buttons	33
7. Pro Tools	33
7.1 Up / Up+ Setup.....	33
7.2 Pro Tools Setup.....	33
7.3 Basic Functions	34
Auto and Insert Buttons	34
Displays	35
Assignment Buttons.....	35
Assign or Edit Plug-ins	36
V-Pots	37
Solo and Mute Buttons	38
Automation Buttons.....	38
Modifier Buttons.....	39
Window Buttons	39
Multi-Purpose Jog Wheel Section.....	40
Faders.....	41
Dual-Purpose Sel Buttons	41
Transport Buttons	41
8. MCU Mode	42
9. MIDI Mode.....	42
9.1 Midiplus Control Center	42
9.1.1 Firmware Update.....	42
9.1.2 Customizing the Controller.....	43
9.2 Up / Up+ Setup.....	44
9.3 Displays.....	44
9.4 Transport Control.....	45
9.5 Controller Mapping.....	46

1. Introduction

Thank you for purchasing the Up series DAW controller. Up and Up+ compatible with HUI and Mackie Control protocols, seamlessly integrates with most popular DAWs, including customized control mode for Logic Pro®, Pro Tools®, Cubase™, and Ableton® Live™. You can use 8 touch-sensitive motorized faders, 8 clickable rotary encoders, and tons of silicone rubber buttons with colorful RGB backlight, to control your favorite DAWs. Please read this Quick Start Guide carefully before use to help you quickly set up your Up for the first time.

2. Safety Warnings and Instructions:

Please read the following precautions carefully before use to avoid damaging the equipment or causing personal injury. Precautions include but are not limited to the following:

1. Read and understand all the illustrations.
2. Always follow the instructions on the device.
3. Before cleaning the device, always remove the power and the USB cable. When cleaning, use a soft and dry cloth. Do not use gasoline, alcohol, acetone, turpentine or any other organic solutions; do not use a liquid cleaner, spray or cloth that's too wet.
4. Make sure to turn off and disconnect the power if not used for extended periods.
5. Do not use the device near water or moisture, such as a bathtub, sink, swimming pool or similar place.
6. Do not place the device in an unstable position where it might accidentally fall over.
7. Do not place heavy objects on the device.
8. Do not place the device near a heat vent at any location with poor air circulation.
9. Do not open or insert anything into the device that may cause a fire or electrical shock.
10. Do not spill any kind of liquid onto the device.
11. Do not use the device with thunder and lightning present; otherwise it may cause long distance electrical shock.
12. Do not expose the device to hot sunlight.
13. Do not use the device when there is a gas leak nearby.



CAUTION: TO REDUCE THE RISK OF ELECTRIC SHOCK DO NOT REMOVE COVER (OR BACK)
NO USER-SERVICEABLE PARTS INSIDE. REFER SERVICING TO QUALIFIED PERSONNEL

ATTENTION: POUR EVITER LES RISQUES DE CHOC ELECTRIQUE, NE PAS ENLEVER LE COUVERCLE. AUCUN ENTRETIEN DE PIECES INTERIEURES PAR
L'USAGER. CONFIER L'ENTRETIEN AU PERSONNEL QUALIFIE.

AVIS: POUR EVITER LES RISQUES D'INCENDIE OU D'ELECTROCUTION, N'EXPOSEZ PAS CET ARTICLE A LA PLUIE OU A L'HUMIDITE



The lightning flash with arrowhead symbol within an equilateral triangle is intended to alert the user to the presence of uninsulated "dangerous voltage" within the product's enclosure, that may be of sufficient magnitude to constitute a risk of electric shock to persons.



The exclamation point within an equilateral triangle is intended to alert the user of the presence of important operating and maintenance (servicing) instructions in the literature accompanying the appliance.

WARNING: To reduce the risk of fire or electric shock, do not expose this apparatus to rain or moisture.

3. Getting Started

3.1 Connecting Your Up

Please connect the included power supply to the DC socket of Up, and then use the included USB cable (USB A to C or USB C to C) to connect your Up to your computer. The Up is a class-compliant device in both Windows and mac OS, it will install the driver automation, no further installation is necessary.

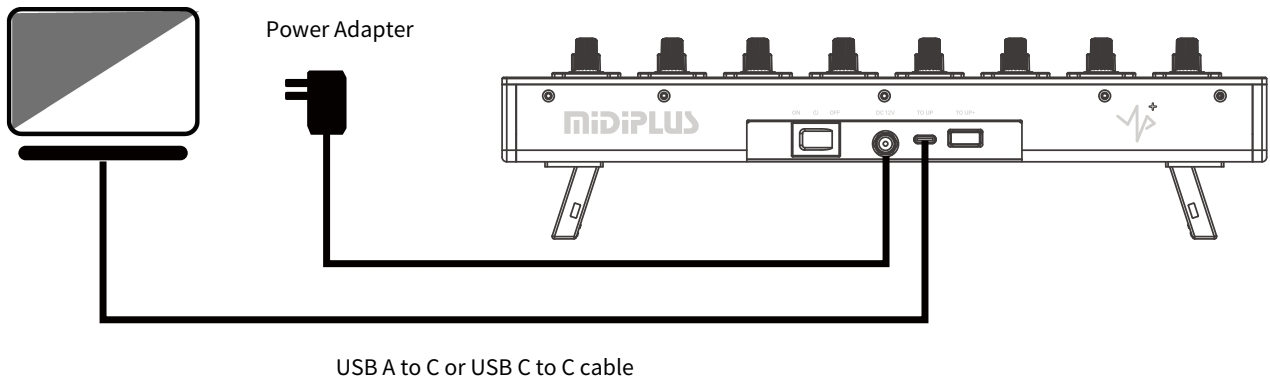

3.2 Connecting Your Up+ (Extender)

The Up can be extended by 3 Up+ (Extender) to create a 32-channel controller, just simple use the included USB A to C cable connect the TO UP+ port (USB A type) of Up to the TO UP port (USB C type) of Up+, and the rest 2 Up+s also connecting by daisy chain.

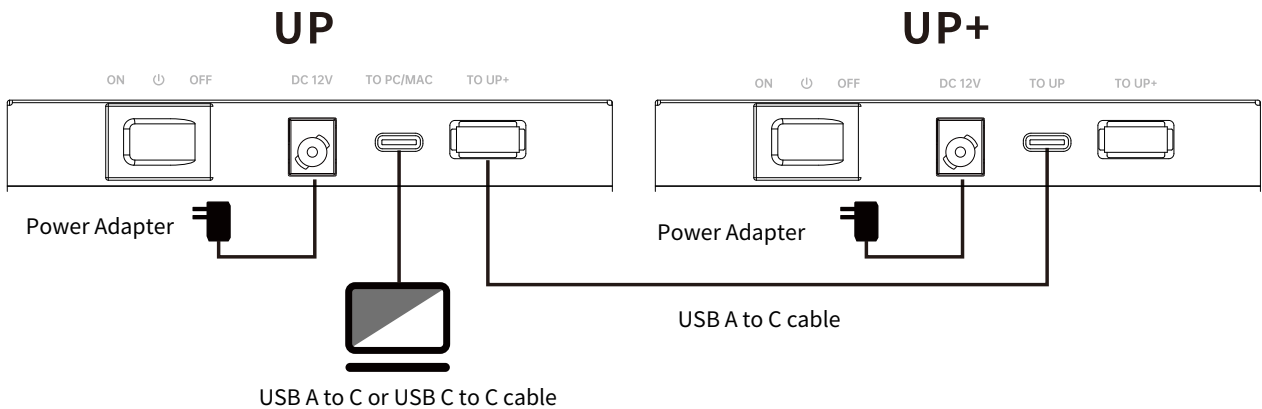

3.3 Changing the Control Mode

The default operation mode of both Up and Up+ is Logic Control Mode, if you are using Logic Pro X, just simply connect the Up and Up+ to your computer. If you want to change the control mode, simply holding down the F1 and F2 buttons while power on the Up and Up+, then you can select Logic, Cubase, Live, HUI, MCU and MIDI mode by press the F1 to F6 buttons.



The Logic, Cubase, and Live mode are customized Mackie Control emulator, which is use your Up and Up+ as a Mackie Control device in Logic Pro X, Cubase/Nuendo, and Ableton Live. HUI mode is recommended for use your Up and Up+ as a HUI emulation device in Pro Tools. MCU mode is a standard Mackie Control emulator use with most DAWs. The MIDI mode allows Up and Up+ to be used as standard MIDI controllers, you can customize mapping the controllers by downloading and installing the Midiplus Control Center software.

3.4 Using the Overlays

The labels for the most of buttons are specific to Logic Pro X, if you are using Cubase/Nuendo, Ableton Live and Pro Tools, you will need to place the included corresponding overlays onto the surface so that the buttons were labelled with the correct functions.

4. Logic Pro X

4.1 Up / Up+ Setup

Make sure you have changed your Up / Up+'s Control mode to Logic mode, please refers to [3.3 Changing the Control Mode](#) chapter.

4.2 Logic Pro Setup

The Up will automatically be added as a Mackie Control device when you launch Logic Pro, if your Up not be added, you can manually configure it as follows:

1. Go to Logic Pro | Settings | Advanced...

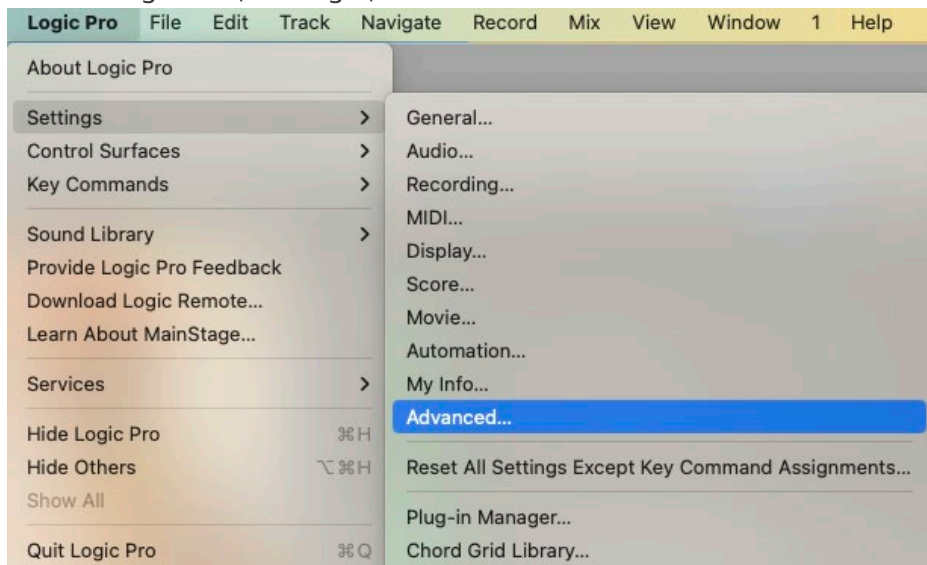

2. Tick "Enable Complete Features"

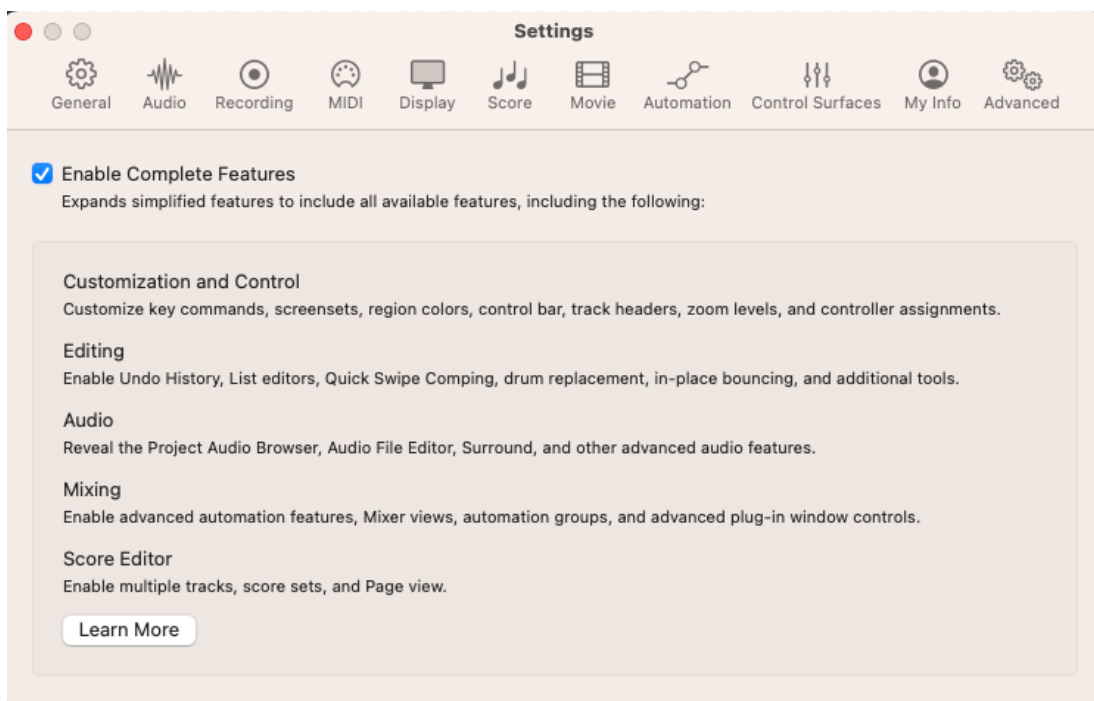

3. Go to Logic Pro | Control Surfaces | Setup...

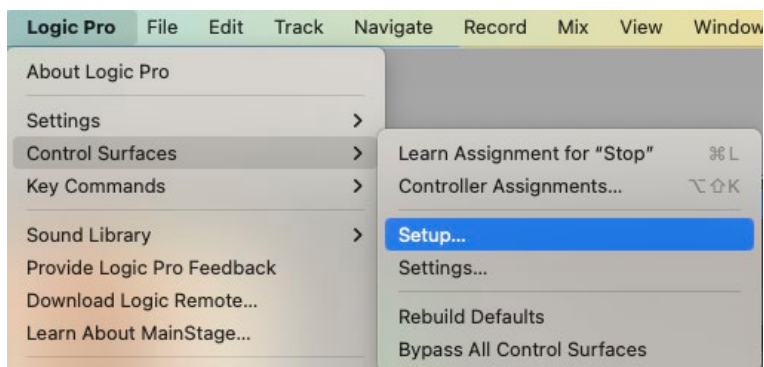

4. Go to New | Install... in the top-left of the window.

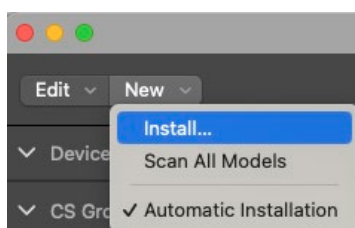

5. Select Mackie Control from the list and click the Add button.

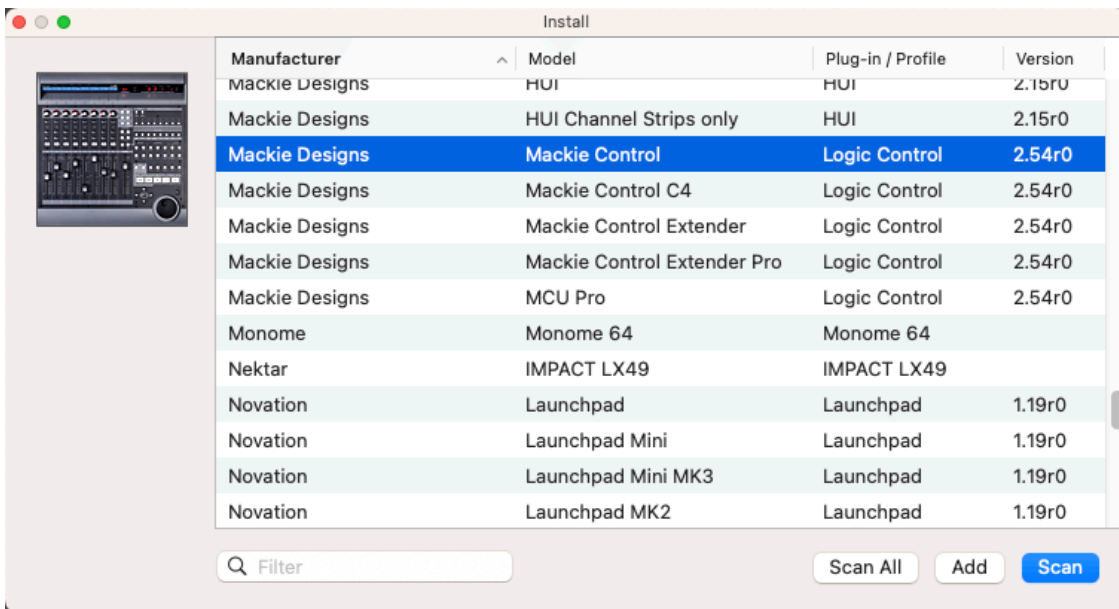

6. Click the image of the Mackie Control and set the Input and Output ports to “Up Port 1”, now your Up is ready to use. If you have connected Up+ to the Up, the Up+s should be set up as extender units through the remaining steps.

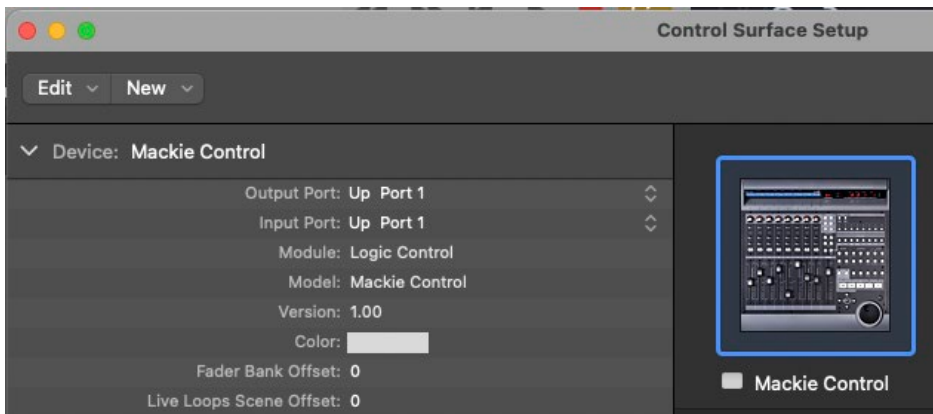

7. Go to New | Install... in the top-left of the window.

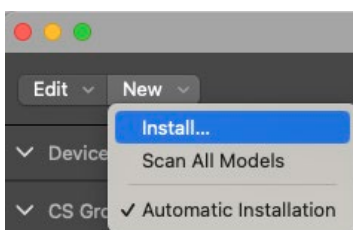

8. Select Mackie Control Extender from the list and click the Add button.

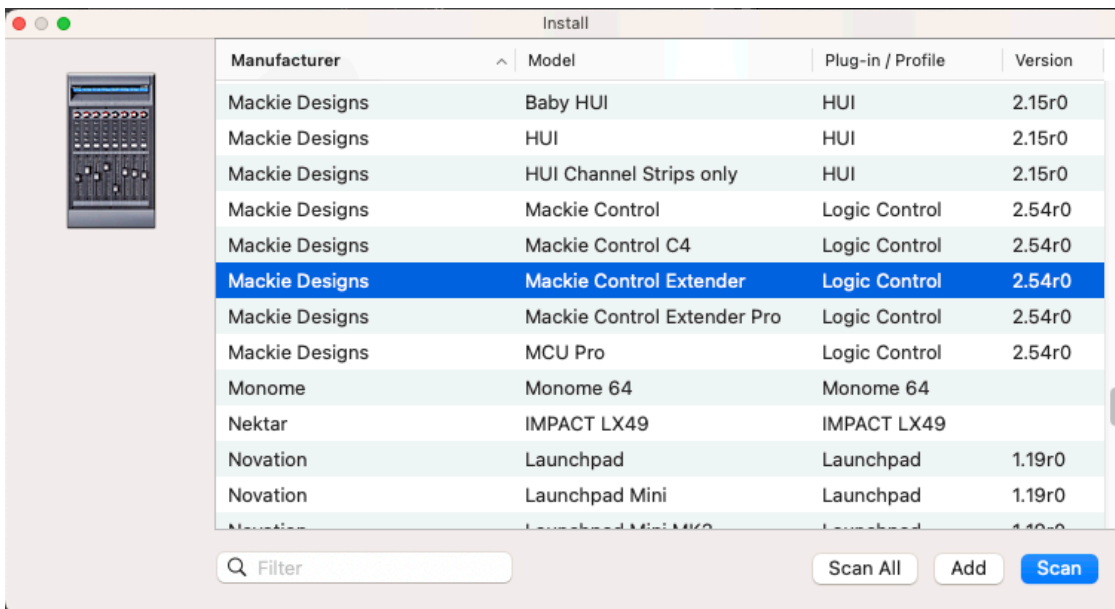

9. Click the image of the Mackie Control Extender and set the Input and Output ports to “Up Port 2”, set the Fader Bank Offset to “8”.

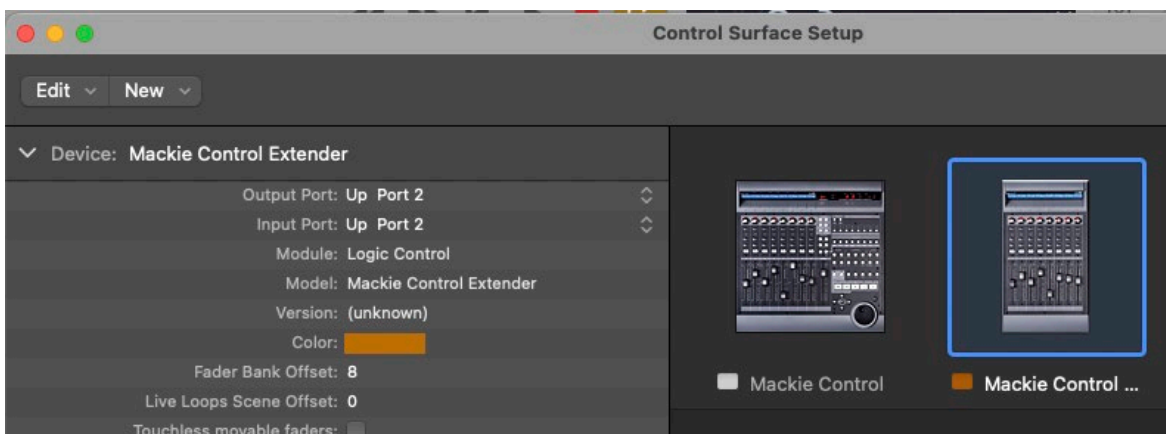

10. Repeat step 7 and step 8, set the subsequent Up+s as Mackie Control Extenders, incrementing the MIDI Port number for each Extender, set the Fader Bank Offset to “16” for the second extender and “24” for the third extender.

4.3 Basic Functions

This section introduces the basic functions of Up using with Logic, for complete functions and features of Mackie Control Protocol, please go to the Logic menu: Help | Logic Pro Control Surfaces Support, then go to the Mackie Control section for reference.

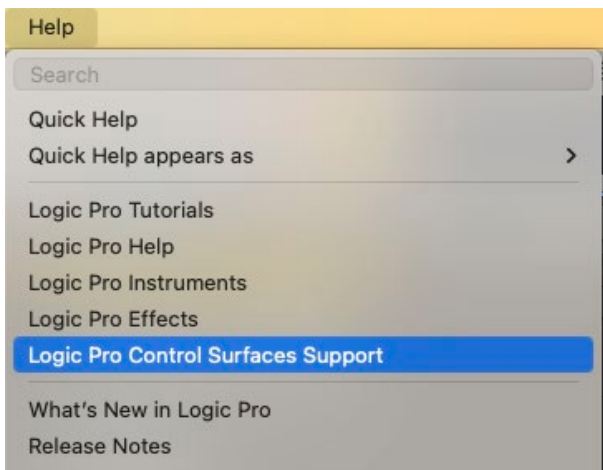

Function / Global View Buttons



The **FUNCTION / GLOBAL VIEW** button lights Orange by default, press one of these 8 buttons (**F1** through **F8**) will switches the Screenset in Logic, when press the **FUNCTION / GLOBAL VIEW** button to switch the backlight to Green, these 8 buttons are used in conjunction with the **GLOBAL** button to display (and edit) specific types of channel strips.

Displays



- **Assignment Mode**

Display the current assignment state of V-Pot.

- **Track Name**

Displays the abbreviated track (or channel) name.

- **Time Display**

Shows the current playhead position, either in musical time divisions (BEATS) or in SMPTE timecode format (SMPTE). Hold down the **FUNCTION / GLOBAL VIEW** button, then press the **SELECT** button to switch between the two time formats.

- **Metering**

Displays the channel metering.

- **Up+ State**

Displays the Up+ icon when the Up+ is connected to Up.

- **V-Pot Readout Bar**

Display the current position of the parameter you are adjusting with the V-Pot.

- **V-Pot Label or Value**

Displays the abbreviated parameter name and its value. Hold down the **FUNCTION / GLOBAL VIEW** button, then press the **REC** button to switch between the two parameter display formats (Name and Value).

Assignment Buttons



Press one of these Assignment buttons to select the type of parameter that you want to control or edit with the channel strip V-Pots, faders, and switches.

- **TRACK**

Channel strip parameters.

- **PAN**

Pan/Surround parameters.

- **EQ**

EQ parameters.

- **SEND**

Send parameters.

- **PLUGIN**

Plug-in selection or Plug-in Edit mode.

- **INST**

Instrument selection or Instrument Edit mode.

V-Pots



The function of V-Pots depending on which assignment mode is currently active, rotate V-Pot is typically used for adjust the channel's send level and pan / balance or to adjust effect or instrument plug-in parameters. Also use to scroll through and choose items such as plug-ins, software instruments, and more from menus, and to determine send destinations.

Press V-Pot is typically used for setting default parameter value or switches between two parameter values, also activate a function which is selected with the V-Pot.

Modifier Buttons

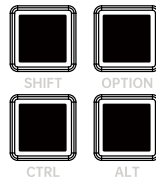

- **SHIFT**

Provides an alternate function or meaning for a button.

- **OPTION**

The function applies to all channel strips. For relative value changes, sets the value to its minimum, default, or maximum, depending on whether you're increasing or decreasing it.

- **CTRL**

Hold down to turn on group clutch and temporarily disable channel strip groups.

- **ALT**

Allows fine-tuning or a variation of the function.

Solo and Mute Buttons



- **S (Solo)**

Use to hear the channel strip in isolation.

- **M (Mute)**

Use to silence the channel.

- **S CLEAR**

Use to disable solo for all channel strips. The **S CLEAR** button will blink whenever any channel is soloed.

- **M CLEAR**

Use to disable mute for all channel strips.

Automation and Group Buttons

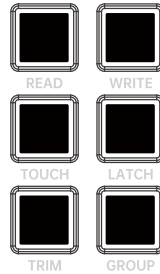

- **READ**

Set selected track's automation to Read or Off.

- **WRITE**

Set selected track's automation to Write.

- **TOUCH**

Set selected track's automation to Touch.

- **LATCH**

Set selected track's automation to Latch.

- **TRIM**

Set selected track's automation to Trim mode, needs to work in combination with Touch and Latch modes.

- **GROUP**

Enter Group Edit mode.

Flip and Global Buttons



- **FLIP**

Activate or deactivate the Flip, Swap, or Zero modes.

- **GLOBAL**

Switch between Arrange view and All view. Use in conjunction with the 8 Global View buttons.

Multi-Purpose Jog Wheel Section



This section contains a clickable Jog Wheel, and 8 buttons which are used to alter the functions of the Jog Wheel .

- **CURSOR**

Use Jog Wheel as computer arrow key, press the Jog Wheel to toggle arrow Left / Right or arrow Up/ Down.

- **SCROLL**

Turn the Jog Wheel to control the playhead scrolling, press the Jog Wheel to enter scrub mode and the **SCROLL** button will blink.

- **ZOOM**

Use Jog Wheel to control zooming, press the Jog Wheel to toggle between horizontal zooming and vertical zooming.

- **MASTER**

Use Jog Wheel to control the Master level.

- **MARKER**

Turn the Jog Wheel to control the playhead scrolling, use the **REWIND** and **FAST FORWARD** buttons to move the playhead through markers.

- **NUDGE**

Use Jog Wheel to move selected audio / MIDI regions or events.

- **BANK**

Use Jog Wheel to shift the active channel bank up or down by one bank.

- **CHANNEL**

Use Jog Wheel to shift the active channel bank up or down by one channel.

Utilities Buttons

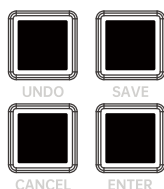

• UNDO

Press to undo the last undoable action. Hold down the **SHIFT** button while pressing **UNDO** to perform a Redo. Hold down the **OPTION** button while pressing **UNDO** to open the Undo History window.

• SAVE

Press to save the current project file. Hold down the **OPTION** button while pressing **SAVE** opens the Save As dialog on the computer screen.

• CANCEL

Press to cancel or exit an alert that appears on your computer screen.

• ENTER

Press to activate the default button in an onscreen alert.

Faders

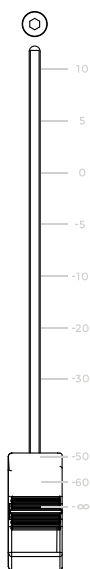

Control the channel level or control other parameters by using Flip mode.

Dual-Purpose Sel Buttons



The **SELECT** button is activated by default, the eight **SEL** (select) buttons are used to choose and activate the channel for channel-based editing or assignment commands, when **REC** button is activated, these eight buttons are used to arm the channel strip for recording.

Transport Buttons

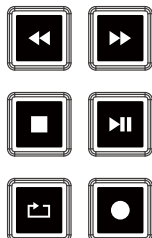

- **REWIND**

Rewinds through your project. Repeated pressing will accelerate the speed.

- **FAST FORWARD**

Fast Forward through your project. Repeated pressing will accelerate the speed.

- **STOP**

Stops playback or recording and stops all other Transport functions. Press the **STOP** button a second time to return the playhead to the project start point or to the beginning of the nearest cycle area if Cycle mode is active.

- **PLAY / PAUSE**

Starts playback from the current playhead position. Press **PLAY** repeatedly to jump to the beginning of the nearest cycle area if Cycle mode is active.

- **CYCLE**

Turns Cycle mode on or off. Hold down the **CYCLE** button then press the **REWIND** or **FAST FORWARD** buttons to set the left or right locator to the current playhead position.

- **RECORD**

Starts recording on the selected MIDI, audio, or software instrument channel strip if it is armed for recording.

5. Cubase/Nuendo

5.1 Up / Up+ Setup

Make sure you have changed your Up / Up+'s Control mode to Cubase mode, please refers to [3.3 Changing the Control Mode](#) chapter.

5.2 Cubase/Nuendo Setup

1. Open Cubase/Nuendo, then go to Studio | Studio Setup...

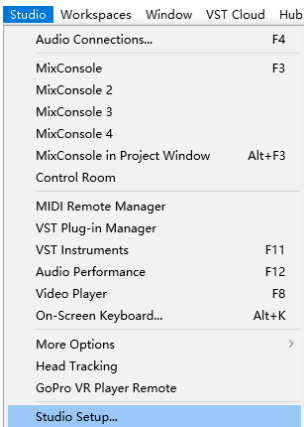

2. Click on the Add Device menu in the Setup window and select Mackie Control from the list.

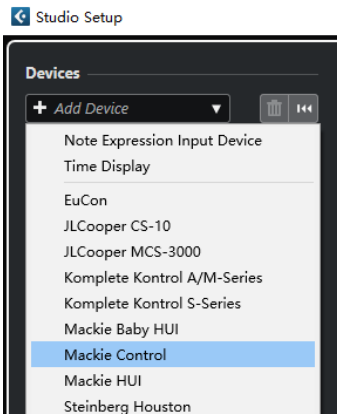

3. Click on the Mackie Control and set the MIDI Input and Output to "Up". If you have connected Up+ to the Up, please continue through the remaining steps, otherwise, please skip to step 7.

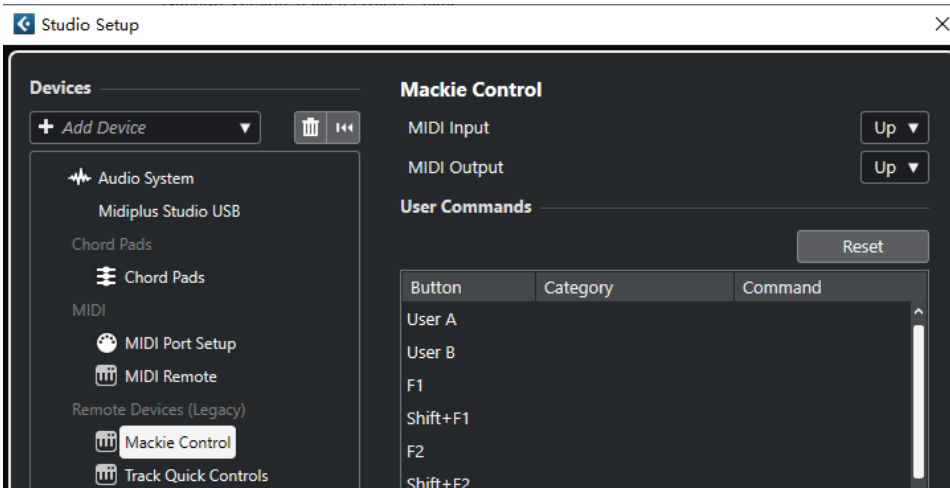

4. Click on the Add Device menu in the Setup window and select Mackie Control from the list.

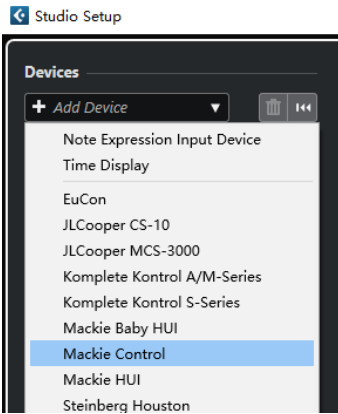

5. Click on the Mackie Control 2 and Set the MIDI Input to "MIDIIN2(Up) " and MIDI Output to "MIDIOUT2(Up) ".

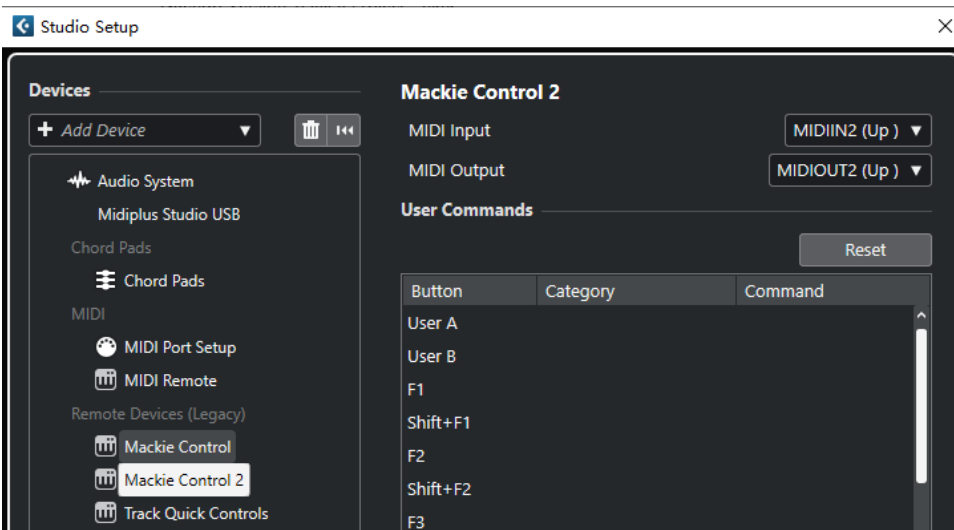

6. Repeat step 4 and step 5 if you have connected more Up+s, set the subsequent Up+s as Mackie Control 3 and 4, incrementing the MIDI Port number for each Mackie Control.

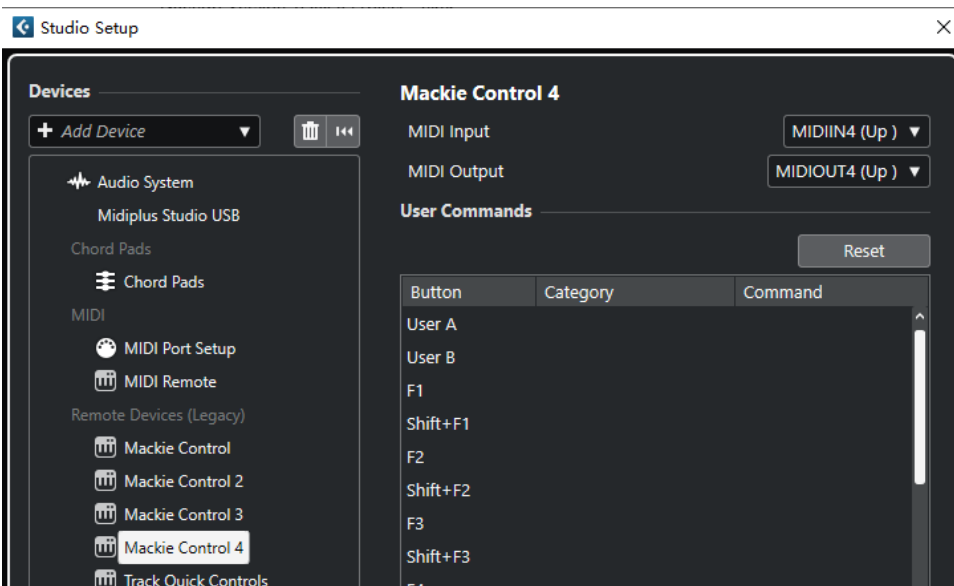

Note: In the Devices list, the topmost device represents the right-most channels.

7. Click on the MIDI Port Setup and make sure that "In All MIDI Inputs" box is unchecked for all Up ports.

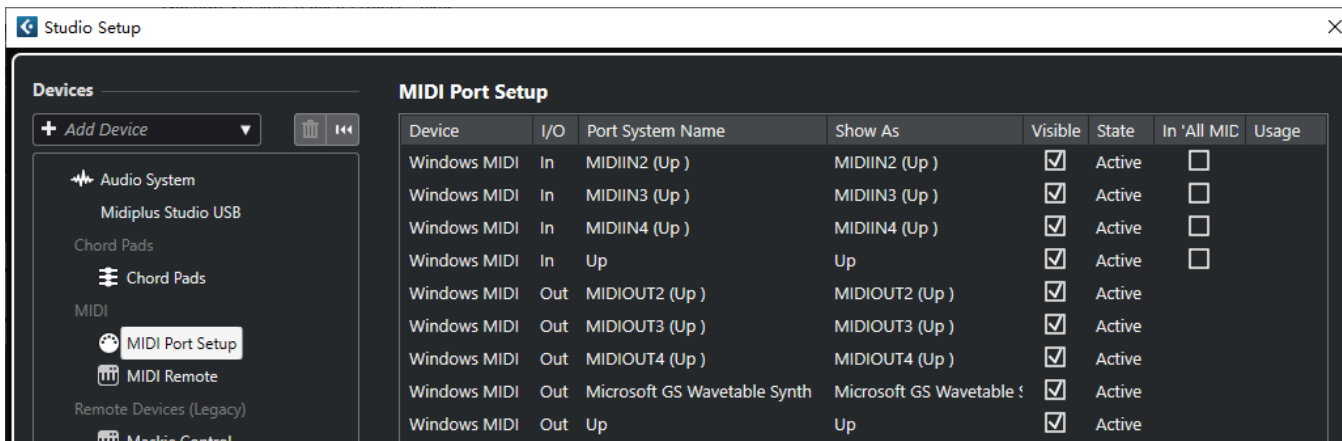

8. Go to Studio | More Options | Mackie Control.

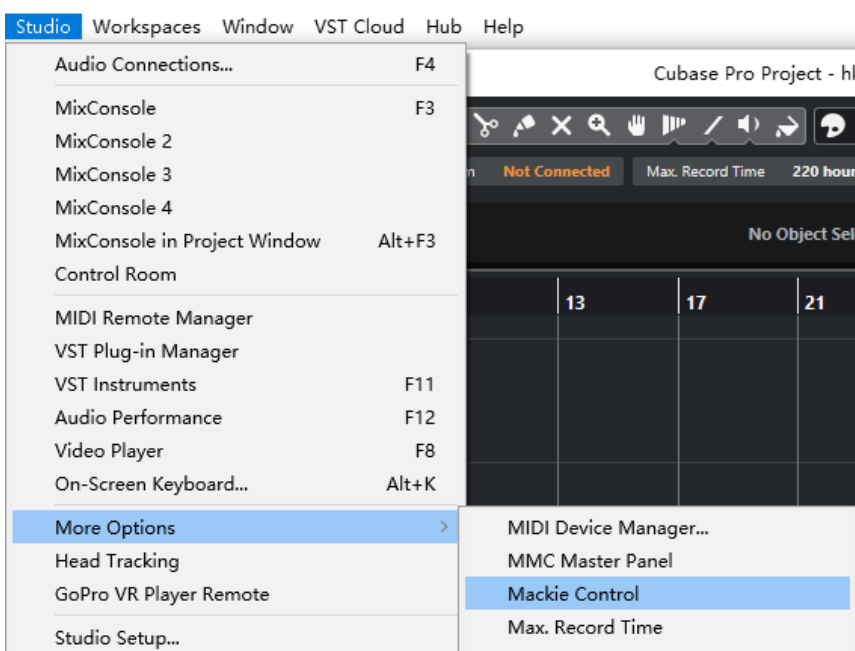

9. Select Cubase from the pop-up menu. Your Up is now ready to use.

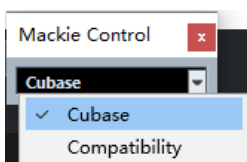

5.3 Basic Functions

This section introduces the basic functions of Up using with Cubase/Nuendo, please place the included Cubase overlays onto the Up before use.

Function / Fader Bank Buttons

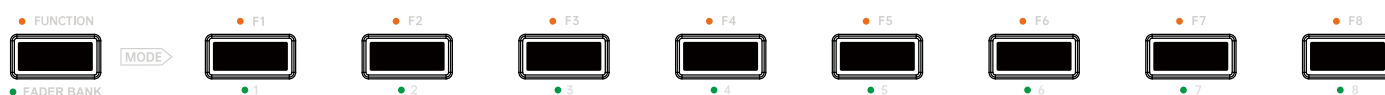

The **FUNCTION / FADER BANK** button lights Orange by default, these 8 buttons (**F1** through **F8**) can control individually assigned functions in the Device Setup dialog of Cubase or Nuendo.

Press the **FUNCTION / FADER BANK** button to switch the backlight to Green, these 8 buttons apply the first 8 individual Channel Visibility Configurations you have created in your MixConsole. Hold down the **SHIFT** button, these 8 buttons apply particular channel types (Audio, Groups, FX Channels etc) to the channel set.

Displays

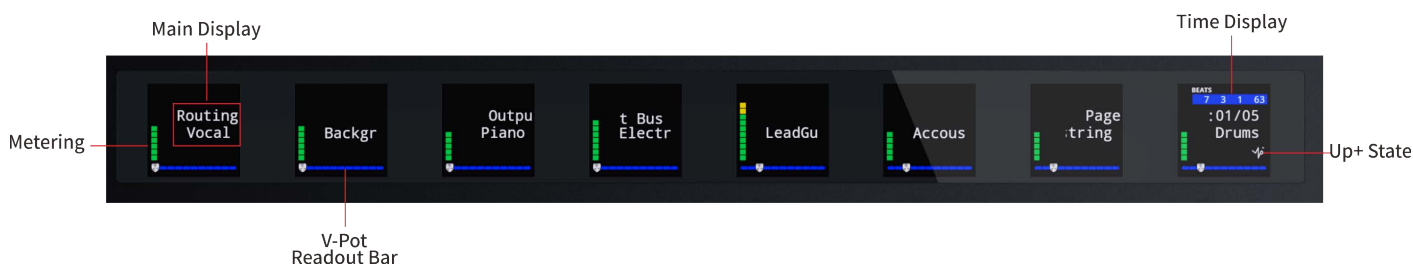

• Main Display

The upper row displays name or value information, press the **NAME/VALUE** button to switch between the two parameter display formats. The lower row displays the track name or V-Pot information.

• Time Display

Shows the current playhead position, either in musical time divisions (BEATS) or in SMPTE timecode format (SMPTE). Press the **SMPTE/BEATS** button to switch between the two time formats.

• Metering

Displays the channel metering.

• Up+ State

Displays the Up+ icon when the Up+ is connected to Up.

• V-Pot Readout Bar

Displays the current position of the parameter you are adjusting with the V-Pot.

Assignment Buttons

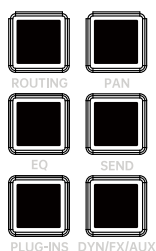

Press one of these Assignment buttons to select the type of parameter that you want to control or edit with the channel strip V-Pots, faders, and buttons.

• ROUTING

Controls the routing settings for all audio channels of your project.

- **PAN**

Pan/Surround parameters.

- **EQ**

EQ parameters.

- **SEND**

Send parameters.

- **PLUG-INS**

Plug-in selection or Plug-in Edit mode.

- **DYN/FX/AUX**

Instrument selection or Instrument Edit mode.

V-Pots



The function of V-Pots depending on which assignment mode is currently active, rotate the V-Pots to navigate in the settings or to edit the values of parameters. In some cases, the V-Pots also serve a push-button function.

Page Buttons

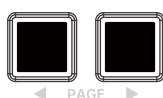

Use to move through the various parameter pages that are available within each V-Pot assignment mode.

Display Buttons

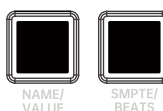

- **NAME/VALUE**

Toggle the parameter display formats between Name and Value.

- **SMPTE/BEATS**

Toggle the time display formats between Timecode and Bar+Beats.

Solo and Mute Buttons



- **S (Solo)**

Use to hear the channel strip in isolation.

- **M (Mute)**

Use to silence the channel.

- **S CLEAR**

Use to disable solo for all channel strips. The **S CLEAR** button will blink whenever any channel is soloed.

- **M CLEAR**

Use to disable mute for all channel strips.

Automation Buttons

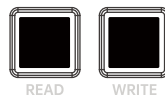

- **READ**

Set selected track's automation to Read or Off.

- **WRITE**

Set selected track's automation to Write.

Hold down **SHIFT** button and press **READ** or **WRITE** button will apply automation to all channels.

Sends, Inst, Master and Mixer

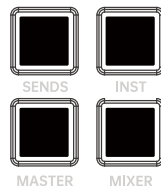

- **SENDS**

Use to control the FX channel insert effects.

- **INST**

Use to control the parameters of the track and rack instruments that are loaded into the VST Instruments slots

- **MASTER**

Use to control the master insert effects of the main output bus.

- **MIXER**

Press to open or close the MixConsole window.

Flip and Edit Buttons



- **FLIP**

Switches the functions of faders and V-Pots.

- **EDIT**

Press to open or close the Channel Settings window for the current channel selection. Hold down **SHIFT** button and press **EDIT** to close the currently active window.

Utilities Buttons

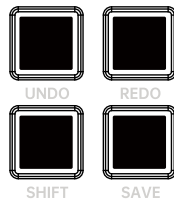

- **UNDO**

Press to undo the last undoable action. Hold down the **SHIFT** button while pressing **UNDO** to open the Edit History dialog.

- **REDO**

Press to restore undone operations.

- **SHIFT**

Provides an alternate function or meaning for a button.

- **SAVE**

Press to save the current project file. Hold down the **SHIFT** button while pressing **SAVE** will save the current project to a new version.

Multi-Purpose Jog Wheel Section



This section contains a clickable Jog Wheel, and 8 buttons which are used to alter the functions of the Jog Wheel .

- **CURSOR**

Use Jog Wheel as computer arrow key, press the Jog Wheel to toggle arrow Left / Right or arrow Up/ Down.

- **SCROLL**

Turn the Jog Wheel to control the playhead scrolling, press the Jog Wheel to enter scrub mode and the **SCROLL** button will blink.

- **ZOOM**

Use Jog Wheel to control zooming, press the Jog Wheel to toggle between horizontal zooming and vertical zooming.

- **MASTER**

Use Jog Wheel to control the Master level.

- **MARKER**

Turn the Jog Wheel to move the playhead through markers. Press the Jog Wheel to add a marker at the current playhead position.

- **TRSPT CTRL**

Use Jog Wheel to move the playhead to locators. Hold down **SHIFT** button and turn the Jog Wheel to set the locators to the current playhead position.

- **BANK**

Use Jog Wheel to shift the active channel bank up or down by one bank.

- **CHANNEL**

Use Jog Wheel to shift the active channel bank up or down by one channel.

Faders

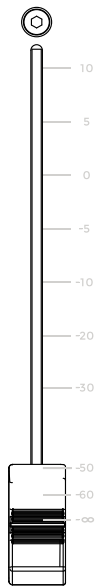

Control the channel level or control other parameters by using Flip mode.

Dual-Purpose Sel Buttons



The **SELECT** button is activated by default, the eight **SEL** (select) buttons are used to choose and activate the channel for channel-based editing or assignment commands, when **REC** button is activated, these eight buttons are used to arm the channel strip for recording.

Transport Buttons

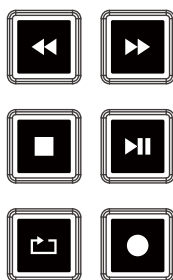

• REWIND

Press and hold to rewinds through your project. Hold down **SHIFT** and press the **REWIND** to move the playhead to the beginning of the project.

• FAST FORWARD

Press and hold to move the playhead forward through your project. Hold down **SHIFT** and press the **FAST FORWARD** to move the playhead to the end of the project.

- **STOP**

Stops playback or recording. Press the **STOP** button a second time to return the playhead to the previous start position.

- **PLAY / PAUSE**

Starts playback from the current playhead position.

- **CYCLE**

Turns Cycle mode on or off.

- **RECORD**

Starts recording on the selected MIDI, audio, or software instrument channel strip if it is armed for recording.

6. Ableton Live

6.1 Up / Up+ Setup

Make sure you have changed your Up / Up+'s Control mode to Live mode, please refers to [3.3 Changing the Control Mode](#) chapter.

6.2 Ableton Live Setup

1. Open Live, then go to Options | Preferences...

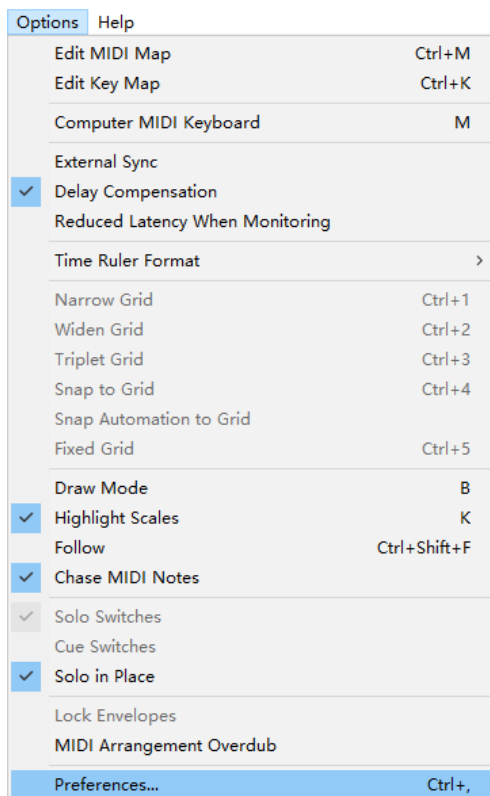

2. Click on the Link Tempo MIDI tab and set Control Surface 1 to Mackie Control and the Input and Output to “Up”.

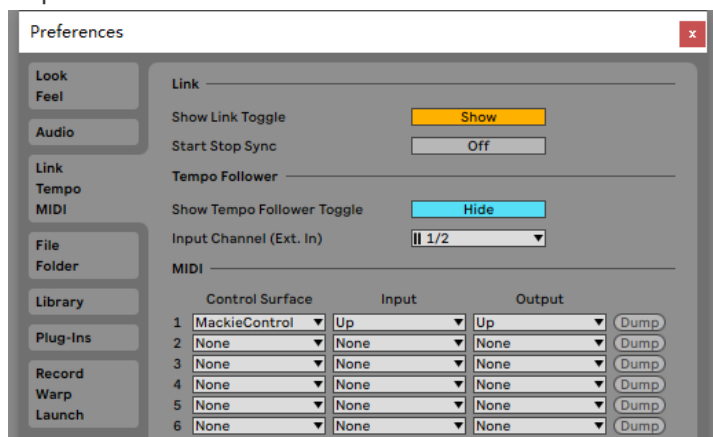

3. If you have connected Up+ to the Up, set Control Surface 2 to Mackie Control XT and the Input and Output to “Up Port 2”. If more Up+ are connected, set the subsequent Up+s as Mackie Control XT, and incrementing the MIDI Port number for each Mackie Control XT.

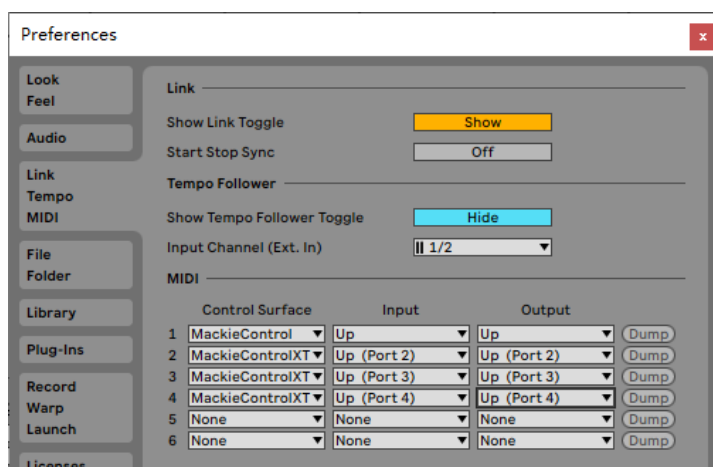

4. Make sure the Track, Sync, and Remote are all ticked for all MIDI Ports of Up.

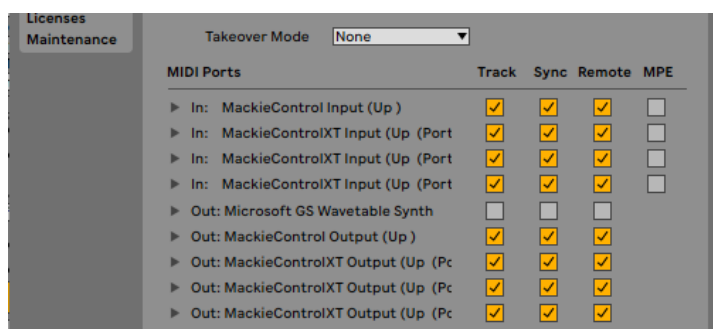

6.3 Basic Functions

This section introduces the basic functions of Up using with Live, please place the included Ableton Live overlays onto the Up before use.

The Top Row Buttons



- **SMPTE/BEATS**

Press to switch between the two time display formats (SMPTE and Beats).

- **FOLLOW**

Activate/Deactivate the Follow Mode.

- **PUNCH IN**

Activate/Deactivate the punch-in point.

- **PUNCH OUT**

Activate/Deactivate the punch-out point.

Note: The other buttons with no label are not available in Live.

Displays



- **Assignment Mode**

Display the current assignment state of V-Pot.

- **Main Display**

Normally the upper row displays track name or V-Pot information, the lower row displays the value controlled by V-Pot. When in Plug-ins mode and Sends mode, a fader is moved, this area displays a label "Volume" and its dB value.

- **Time Display**

Shows the current playhead position, either in musical time divisions (BEATS) or in SMPTE timecode format (SMPTE). Press the **SMPTE/BEATS** button to switch between the two time formats.

- **Metering**

Displays the channel metering.

- **Up+ State**

Displays the Up+ icon when the Up+ is connected to Up.

• V-Pot Readout Bar

Display the current position of the parameter you are adjusting with the V-Pot.

Assignment Buttons

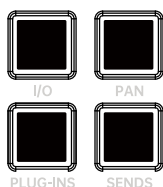

Press one of these Assignment buttons to select the type of parameter that you want to control or edit with the channel strip V-Pots, faders, and switches.

• I/O

Controls the Input/Output settings for all channels of your project. Pressing repeatedly will cycle through: Input Type, Input Channel, Output Type, and Output Channel.

• PAN

Control the Pan parameters with V-Pots.

• PLUG-INS

Plug-in Edit mode. Once a track is selected, press **PLUG-INS** once, all the plug-ins of the currently selected track will display on the lower row of Main Display, press the V-Pot to select a plug-in for edit, press **PLUG-INS** again to return to plug-in selection. You can use the **PAGE** buttons to access more than 8 plug-ins or parameters.

• SEND

Control the Send level for the currently selected track.

Flip and Returns Buttons

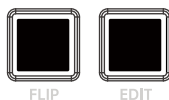

• FLIP

Switches the functions of faders and V-Pots.

• RETURNS

Press to switch between Return Tracks and Audio/MIDI Tracks.

V-Pots



The function of V-Pots depending on which assignment mode is currently active, rotate the V-Pots to navigate in the settings or to edit the values of parameters. In some cases, the V-Pots also serve a push-button function.

Page Buttons

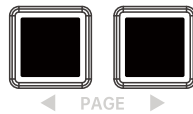

Use to move through the various pages when in Plug-ins mode.

Home and End Buttons

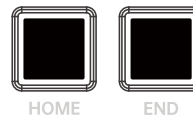

- **HOME**

Move insert marker to the beginning.

- **END**

Move insert marker to the end.

Solo and Mute Buttons



- **S (Solo)**

Use to hear the channel strip in isolation.

- **M (Mute)**

Use to silence the channel.

- **S CLEAR**

Use to disable solo for currently focused bank of channel strips. The **S CLEAR** button will blink whenever any channel is soloed.

- **M CLEAR**

Use to disable mute for currently focused bank of channel strips.

Sess/Arr. and Clip/FX Buttons



- **SESS/ARR**

Toggle Session/Arrangement View.

- **CLIP/FX**

Toggle Device/Clip View.

Browser and Detail Buttons



- **BROWSER**

Hide/Show Browser.

- **DETAIL**

Hide/Show Detail View.

Draw and B.T.A. Buttons

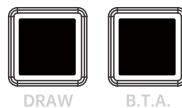

- **DRAW**

Toggle Draw Mode.

- **B.T.A.**

Back to Arrangement.

Utilities Buttons

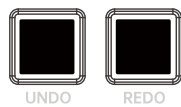

- **UNDO**

Undo the last action.

- **REDO**

Redo the last action.

Modifier Buttons

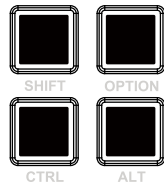

These four Modifier buttons are similar to the modifier keys on your computer keyboard.

Multi-Purpose Jog Wheel Section



This section contains a clickable Jog Wheel, and 8 buttons which are used to alter the functions of the Jog Wheel .

- **LEFT/RIGHT and UP/DOWN**

Always use in combination with **ZOOM** button.

- **ZOOM and SCROLL**

The function of these two buttons depends on the current view in Live, the **ZOOM** button Will always use in combination with **LEFT/RIGHT** or **UP/DOWN** buttons.

- **Session View**

Rotate the Jog Wheel to select the scene or clip, which depends on either the **LEFT/RIGHT** or **UP/DOWN** button is activated, press **ZOOM** to launch the currently selected clip, press **SCROLL** to launch the currently selected scene.

- **Arrangement View**

Rotate the Jog Wheel to control horizontal zooming or vertical zooming, which depends on either the **LEFT/RIGHT** or **UP/DOWN** button is activated. Moves the cursor through your session while **SCROLL** is activated.

- **MARKER**

Rotate the Jog Wheel to move the playhead through markers. Press the Jog Wheel to add a marker at the current playhead position.

- **MASTER**

Use Jog Wheel to control the Master level.

- **BANK**

Use Jog Wheel to shift the active channel bank up or down by one bank.

- **CHANNEL**

Use Jog Wheel to shift the active channel bank up or down by one channel.

Faders

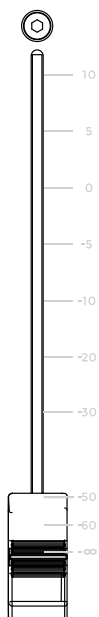

Control the channel level or control other parameters by using Flip mode.

Dual-Purpose Sel Buttons



The **SELECT** button is activated by default, the eight **SEL** (select) buttons are used to choose and activate the channel for channel-based editing or assignment commands, when **REC** button is activated, these eight buttons are used to arm the channel strip for recording.

Transport Buttons

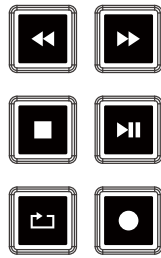

- **REWIND**

Press and hold to move the cursor backward through your session.

- **FAST FORWARD**

Press and hold to move the cursor forward through your session.

- **STOP**

Stops playback or recording. Press again to return the insert marker to the beginning.

- **PLAY / PAUSE**

Starts playback from the start marker position. Press again to restart playback from the start marker position.

- **LOOP**

Toggle Loop selection.

- **RECORD**

Starts recording on the track if it is armed for recording.

7. Pro Tools

7.1 Up / Up+ Setup

Make sure you have changed your Up / Up+'s Control mode to HUI mode, please refers to [3.3 Changing the Control Mode](#) chapter.

7.2 Pro Tools Setup

1. Open Pro Tools, then go to Setup | Peripherals...

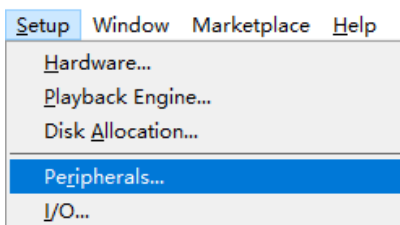

2. Click on the MIDI Controllers tab, set the #1 row as a **HUI Type, Receive From Up** and then **Send To Up**.

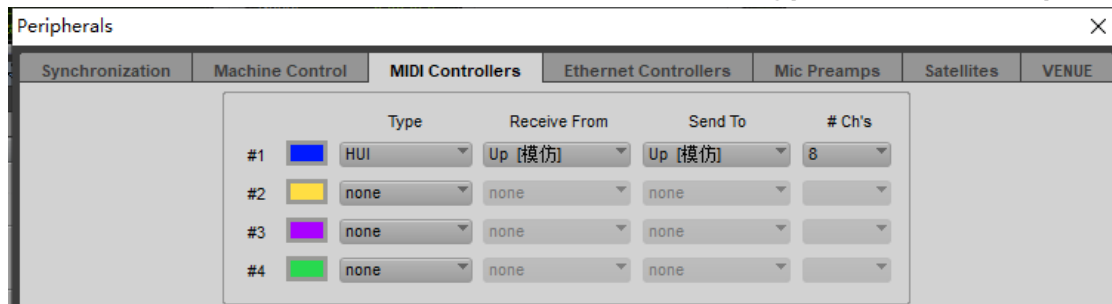

3. If you have connected Up+ to the Up, set the subsequent Up+s as **HUI Type** in the remaining row, and incrementing the MIDI Port number for the **Receive From** and **Send To** of each row.

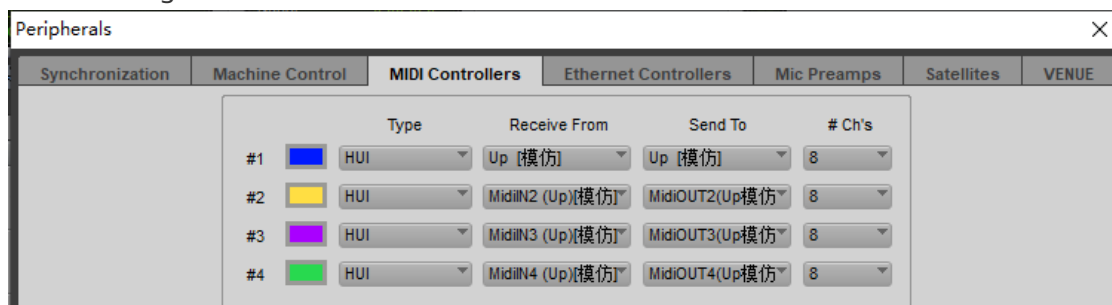

7.3 Basic Functions

This section introduces the basic functions of Up using with Pro Tools, please place the included Pro Tools overlays onto the Up before use.

Auto and Insert Buttons



- **AUTO Mode**

These eight buttons acts as Automation select buttons when illuminates dimmed Blue, hold down to displays the current automation state for the channel, then press the Automation buttons (Read, Write, Touch, Latch, Trim and Off) to change the automation state for corresponding channel.

- **INSERT Mode**

These eight buttons use to select a channel for plug-in and insert editing, when changes the V-Pot function to Plugin, and these buttons will illuminate dimmed Orange.

Displays

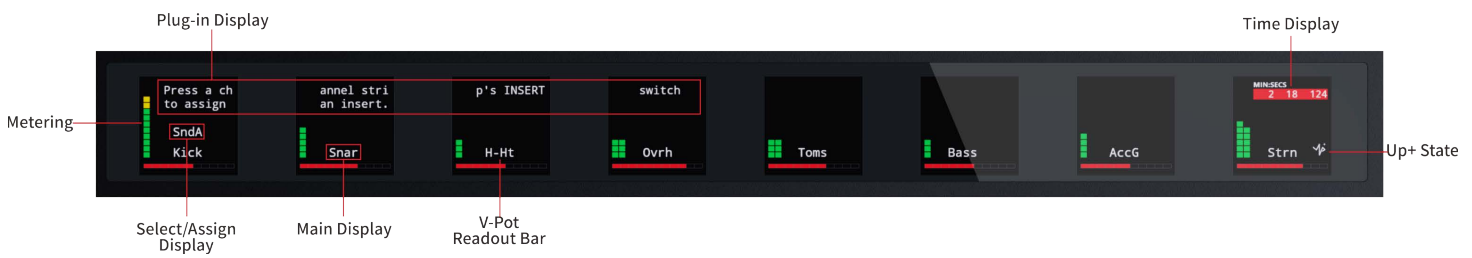

• Plug-in Display

This area shows information about individual channel inserts, plug-in parameters (for plug-in editing), and messages about Pro Tools or HUI status.

• Time Display

Shows the current session time position in standard formats, as selected in the Pro Tools software.

• Metering

Displays the channel metering.

• Select/Assign Display

Shows the assignment status for V-Pot.

• Main Display

Shows the abbreviated channel name, or displays a parameter name or value during edit operations.

• V-Pot Readout Bar

Display the current position of the parameter you are adjusting with the V-Pot.

• Up+ State

Displays the Up+ icon when the Up+ is connected to Up.

Assignment Buttons

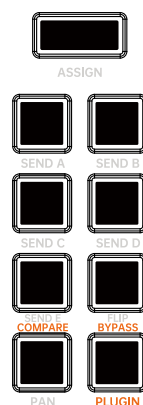

• ASSIGN

Assign the routing of sends. Press the **ASSIGN** button, the **ASSIGN** button will blink, press a **SEND** button (A - E), rotate the V-Pot to choose the desired destination, press the V-Pot to confirm the assignment for that channel, or press **ASSIGN** to confirm all of your assignments at once. To change all channel to the same destination, rotate a V-Pot to choose the desired destination, press **OPTION/ALL** and the V-Pot to confirm.

• **SEND A - E**

Select a channel send (Send A - E) to control.

• **FLIP**

Active the Send Flip Mode, in this mode, you can use faders to control Send level, rotate the V-Pot to control the Pan of the current selected Send, press the V-Pot to toggle Sends between pre and post.

• **PAN**

Control the Pan for every channels, press again to switch to control the Right Pan for stereo channels.

• **PLUGIN**

Changes the V-Pot function to Plugin. There are orange labels beneath the **SEND E** and **FLIP** buttons, you can access their functions while the **PLUGIN** button is activated.

• **COMPARE**

Compare edited plug-in parameter settings to the original settings

• **BYPASS**

Bypass the individual Inserts or selected Plug-ins.

Assign or Edit Plug-ins

Press the **PLUGIN** button to enter the Plug-in mode, use the **INSERT** (1 - 8) buttons, V-Pot (1 - 5), **COMPARE** button and **BYPASS** buttons to assign or edit plug-ins.

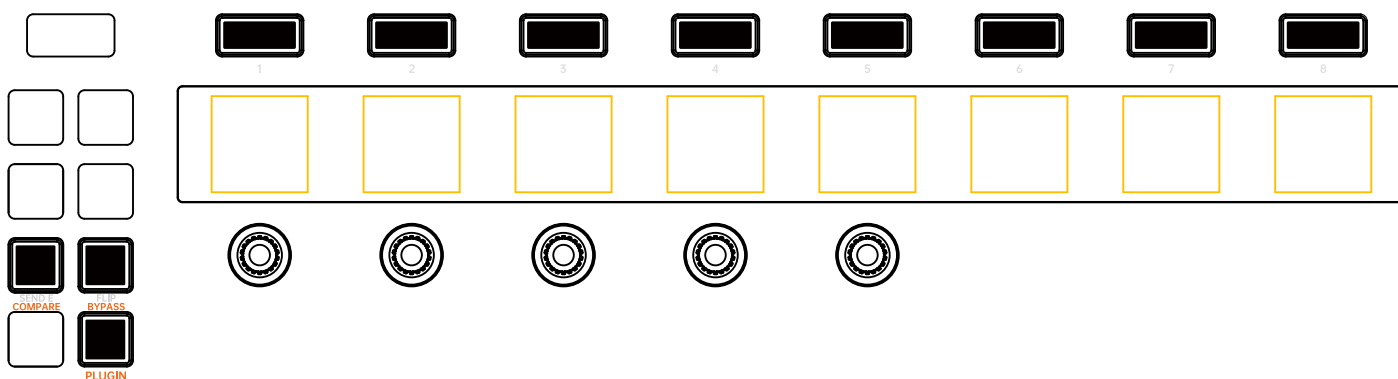

• **Assign Plug-ins**

- 1, To assign plug-ins for a channel, press the **PLUGIN** button to enter the Plug-in mode,
- 2, Press a **INSERT** button to select a channel.
- 3, Press the V-Pot 5 to enter the plug-in assign mode,
- 4, Rotate V-Pot (1 - 4) to assign plug-ins for insert 1 - 4 and press the V-Pot to confirm.

5, Rotate the V-Pot 5 to toggle between displaying inserts 1 - 4 or insert 5, press the V-Pot 5 to confirm all of your assignments at once.

• Edit Plug-ins

- 1, To edit assigned plug-ins for a channel, press the **PLUGIN** button to enter the Plug-in mode,
- 2, Press a **INSERT** button to select a channel.
- 3, Press the V-Pot (1 - 4) to select the plug-in for editing or rotate the V-Pot 5 to displaying inserts 1 - 4 or insert 5.
- 4, Use the V-Pot (1 - 4) to change parameters of plug-in, and rotate the V-Pot 5 to access the various pages of parameters.
- 5, Double press the **INSERT** button to switch between inserts.

V-Pots



The function of V-Pots depending on which assignment mode is currently active, rotate the V-Pots to navigate in the settings or to edit the values of parameters. In some cases, the V-Pots also serve a push-button function.



• CANCEL

Press to cycle through tools, or cancel the on-screen modal dialog.

• ENTER

Press to define a memory location or marker, or confirm the on-screen modal dialog.

• Q.PUNCH

Toggle the QuickPunch recording mode on and off.

• EDIT

There are orange labels beneath the **CANCEL** and **ENTER** buttons, you can hold down the **EDIT** button to access their functions.

• UNDO

Hold down the **EDIT** button then press **UNDO** to undo the last edit operation, press **ALT/FINE + SHIFT/ADD + UNDO** to perform a redo.

• SAVE

Hold down the **EDIT** button then press **SAVE** twice to save the session.

Solo and Mute Buttons



- **S (Solo)**

Use to hear the channel strip in isolation.

- **M (Mute)**

Use to silence the channel.

Automation Buttons



- **READ**

Hold down the **READ** button then press the **AUTO** (1 - 8) buttons to set the corresponding channel into Read mode.

- **WRITE**

Hold down the **WRITE** button then press the **AUTO** (1 - 8) buttons to set the corresponding channel into Write mode.

- **TOUCH**

Hold down the **TOUCH** button then press the **AUTO** (1 - 8) buttons to set the corresponding channel into Touch mode.

- **LATCH**

Hold down the **LATCH** button then press the **AUTO** (1 - 8) buttons to set the corresponding channel into Latch mode.

- **TRIM**

Hold down the **TRIM** button then press the **AUTO** (1 - 8) buttons to toggle the Trim status of the corresponding channel.

- **OFF**

Hold down the **OFF** button then press the **AUTO** (1 - 8) buttons to disable the corresponding channel's automation.

Hold down the **OPTION/ALL** button and press an automation button to change all channels for automation.

• **DEFAULT**

Returns a channel strip's faders and V-Pots to their default settings.

- To returns a channel strips's fader to its default setting, press **DEFAULT + SEL** button.
- To returns a channel strips's Pan to its default setting, pressing the **PAN** button changes the V-Pot function to Pan, then press **DEFAULT + V-Pot** button.
- To returns a channel strips's Send to its default setting, pressing one of the **SEND A - E** button changes the V-Pot function to Send, then press **DEFAULT + V-Pot** button.
- To returns a channel strips's Plugin to its default setting, pressing the **PLUGIN** button changes the V-Pot function to Plugin, then press **DEFAULT + COMPARE** button.
- To return all channel strip's fader, Pan, and Send to their default settings, hold down the **OPTION/ALL** button while perform the operations.

• **AUTO ENABLE**

There are orange labels beneath the Automation buttons, you can hold down the **AUTO ENABLE** button to access their functions.

When hold down the **AUTO ENABLE** button, then press the automation (**FADER, MUTE, PLUG-IN, PAN, SEND, and SEND MUTE**) buttons to enable writing automation for their corresponding parameters, press the **SUSPEND** button to bypass all automation.

Modifier Buttons

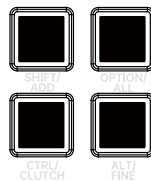

These four buttons serve the same functions as the corresponding buttons on the computer keyboard.

Window Buttons

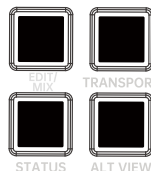

• **EDIT/MIX**

Toggle between Edit window and Mix window.

• **TRANSPORT**

Toggle Transport window.

• **STATUS**

Toggle the Session Setup window.

- **ALT VIEW**

Toggle the Plug-in window.

Multi-Purpose Jog Wheel Section

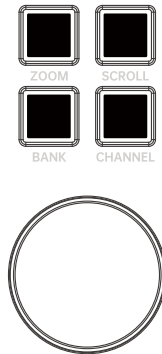

This section contains a clickable Jog Wheel, and 4 buttons which are used to alter the functions of the Jog Wheel .

- **ZOOM:**

Use Jog Wheel to control zooming, press the Jog Wheel to toggle between horizontal zooming and vertical zooming.

- **SCROLL:**

Turn the Jog Wheel to control the playhead scrolling, press the **SCROLL** twice to enter scrub mode and the **SCROLL** button will blink.

- **BANK:**

Use Jog Wheel to shift the active channel bank up or down by one bank.

- **CHANNEL:**

Use Jog Wheel to shift the active channel bank up or down by one channel.

Faders

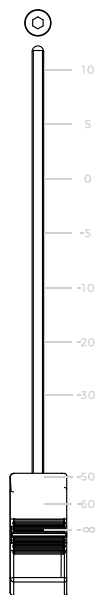

Control the channel level or control the send level by using Send Flip mode.

Dual-Purpose Sel Buttons



The **SELECT** button is activated by default, the eight **SEL** (select) buttons are used to choose and activate the channel for channel-based editing or assignment commands, when **REC** button is activated, these eight buttons are used to arm the channel strip for recording.

Transport Buttons

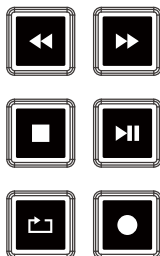

- **REWIND**

Press and hold to move the cursor backward through your session.

- **FAST FORWARD**

Press and hold to move the cursor forward through your session.

- **STOP**

Stops playback or recording.

- **PLAY / PAUSE**

Starts playback from the cursor position.

- **LOOP**

Toggle Loop playback mode.

- **RECORD**

Arms Pro Tools for recording.

8. MCU Mode

In addition to the above four customized modes, the Up and Up+ also has a standard Mackie Control mode for you to use with other DAWs. Please refer to [3.3 Changing the Control Mode](#) chapter to change your Up and Up+'s Control mode to MCU mode, then add the Mackie Control device in your DAW. For specific steps, please refer to the user manual of the DAW you are using.

9. MIDI Mode

To use MIDI mode, make sure that the firmware of Up / Up+ is V0.1.0.7 or later. You can upgrade to the latest firmware through the Midiplus Control Center application.

9.1 Midiplus Control Center

Firmware Update

Visit the Midiplus official website or [click here](#) to find the corresponding OS (Windows/mac) version of the Midiplus Control Center application, then download and install it. After connecting the Up / Up+ to the computer and turning on the power, the Midiplus Control Center will automatically recognize Up / Up+.



Click on the "☰" icon in the upper right corner, in the right pop-up bar you can see the current firmware version of the connected device and the latest firmware version, click the "Update" button to upgrade the current device to the latest firmware. Do not disconnect the device or turn off the power until the upgrade progress is completed.

Customizing the Controller

Once the firmware upgrade is completed, click on a button, fader, etc. of the device image in the Midiplus Control Center to select and customize the MIDI mapping. Once finished, click the "Send" icon in the lower left corner to send the changes to the device.

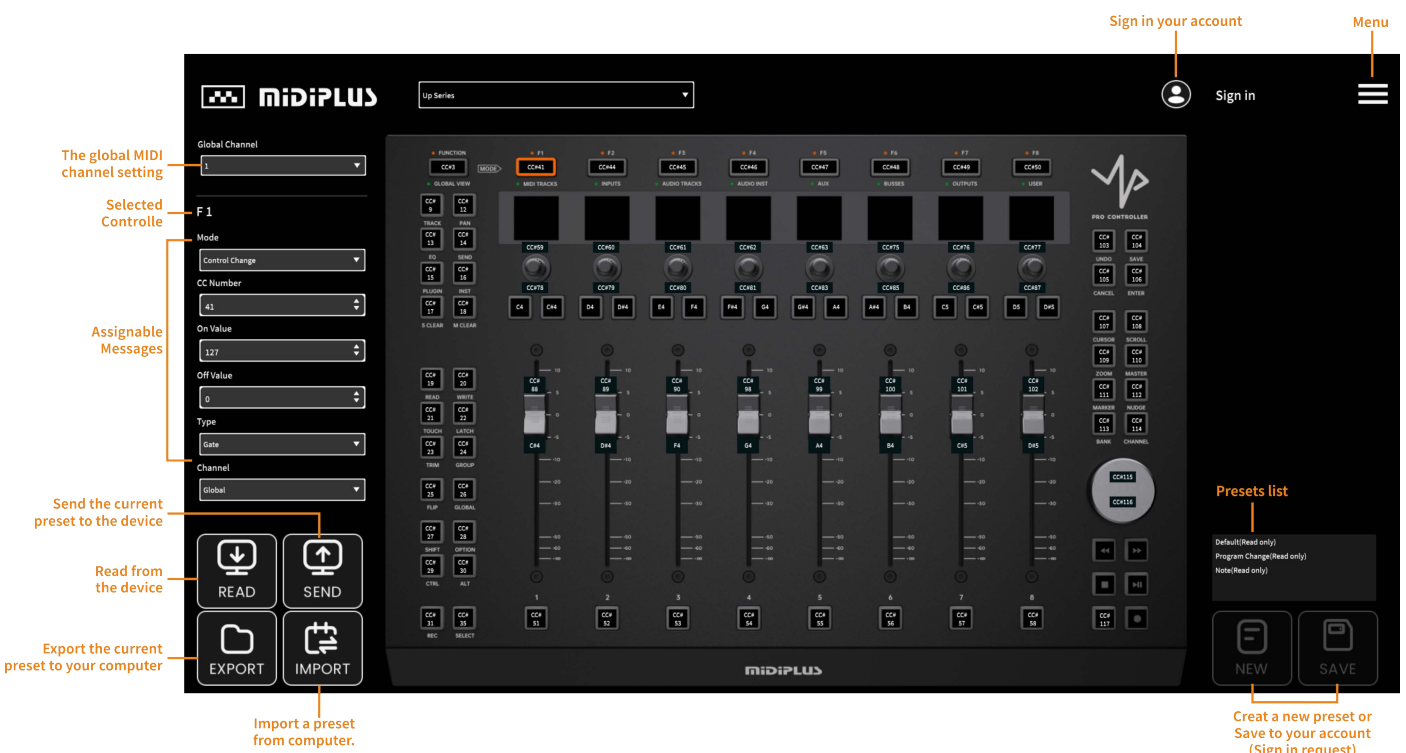

9.2 Up / Up+ Setup

Please refer to the [3.3 Changing the Control Mode](#) chapter to change the control mode to MIDI Mode.

9.3 Displays



When there is no operating controller, the eight displays of Up / Up+ will display four rows of MIDI message, which can display the MIDI mapping of the corresponding controller. The corresponding controller for each row is as follows:

Display	Position	Controllers
	Row #1	F1 - F8 Buttons
	Row #2	8 V-Pots
	Row #3	8 Faders
	Row #4	8 SEL Buttons

When you operate any controller, Up / Up+'s eight displays will show according to the area where the controller is located, and up to eight controllers' MIDI messages can be displayed at the same time. Each display corresponds to a controller as shown below:

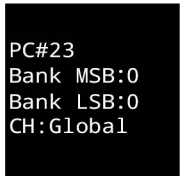

When operating the controller, the display will show 3 or 4 rows of MIDI messages depending on the type of controller (CC#, Note or Program Change):

Display			
Type	CC#	Note	Program Change
Row #1	CC# Number	Note and Status	Program Change Number
Row #2	Control Value	Velocity Value	Bank MSB
Row #3	MIDI Channel	MIDI Channel	Bank LSB
Row #4	None	None	MIDI Channel

9.4 Transport Control

The Up's Transport controls (excluding the Cycle button) send standard MMC (MIDI Machine Control) messages in MIDI mode. When setting up your DAW, simply select the first MIDI In port of the UP as the MIDI input. If a device ID is required to set up a MIDI Machine Control device, enter 127.

Controllers	SysEx Message
Rewind	F0 7F 7F 06 05 F7
Fast Forward	F0 7F 7F 06 04 F7
Stop	F0 7F 7F 06 01 F7
Play	F0 7F 7F 06 02 F7
Record	F0 7F 7F 06 06 F7

9.5 Controller Mapping

Label	Type	Message	MIDI Channel	Label	Type	Message	MIDI Channel
Function	CC#	CC#3	Global	VPot 3 Rotate	CC#	CC#61	Global
Track	CC#	CC#9	Global	VPot 4 Rotate	CC#	CC#62	Global
Pan	CC#	CC#12	Global	VPot 5 Rotate	CC#	CC#63	Global
EQ	CC#	CC#13	Global	VPot 6 Rotate	CC#	CC#75	Global
Send	CC#	CC#14	Global	VPot 7 Rotate	CC#	CC#76	Global
Plugin	CC#	CC#15	Global	VPot 8 Rotate	CC#	CC#77	Global
Inst	CC#	CC#16	Global	VPot 1 Switch	CC#	CC#78	Global
S Clear	CC#	CC#17	Global	VPot 2 Switch	CC#	CC#79	Global
M Clear	CC#	CC#18	Global	VPot 3 Switch	CC#	CC#80	Global
Read	CC#	CC#19	Global	VPot 4 Switch	CC#	CC#81	Global
Write	CC#	CC#20	Global	VPot 5 Switch	CC#	CC#83	Global
Touch	CC#	CC#21	Global	VPot 6 Switch	CC#	CC#85	Global
Latch	CC#	CC#22	Global	VPot 7 Switch	CC#	CC#86	Global
Trim	CC#	CC#23	Global	VPot 8 Switch	CC#	CC#87	Global
Group	CC#	CC#24	Global	Solo 1	Note	C 4	Global
Flip	CC#	CC#25	Global	Solo 2	Note	D 4	Global
Global	CC#	CC#26	Global	Solo 3	Note	E 4	Global
Shift	CC#	CC#27	Global	Solo 4	Note	F#4	Global
Option	CC#	CC#28	Global	Solo 5	Note	G#4	Global
Ctrl	CC#	CC#29	Global	Solo 6	Note	A#4	Global
Alt	CC#	CC#30	Global	Solo 7	Note	C 5	Global
Rec	CC#	CC#31	Global	Solo 8	Note	D 5	Global
Select	CC#	CC#35	Global	Mute 1	Note	C#4	Global
F1	CC#	CC#41	Global	Mute 2	Note	D#4	Global
F2	CC#	CC#44	Global	Mute 3	Note	F 4	Global
F3	CC#	CC#45	Global	Mute 4	Note	G 4	Global
F4	CC#	CC#46	Global	Mute 5	Note	A 4	Global
F5	CC#	CC#47	Global	Mute 6	Note	B 4	Global
F6	CC#	CC#48	Global	Mute 7	Note	C#5	Global
F7	CC#	CC#49	Global	Mute 8	Note	D#5	Global
F8	CC#	CC#50	Global	Fader 1 Touch	Note	E 5	Global
Sel 1	CC#	CC#51	Global	Fader 2 Touch	Note	F 5	Global
Sel 2	CC#	CC#52	Global	Fader 3 Touch	Note	F#5	Global
Sel 3	CC#	CC#53	Global	Fader 4 Touch	Note	G 5	Global
Sel 4	CC#	CC#54	Global	Fader 5 Touch	Note	G#5	Global
Sel 5	CC#	CC#55	Global	Fader 6 Touch	Note	A 5	Global
Sel 6	CC#	CC#56	Global	Fader 7 Touch	Note	A#5	Global
Sel 7	CC#	CC#57	Global	Fader 8 Touch	Note	B 5	Global
Sel 8	CC#	CC#58	Global	Fader 1	CC#	CC#88	Global
VPot 1 Rotate	CC#	CC#59	Global	Fader 2	CC#	CC#89	Global
VPot 2 Rotate	CC#	CC#60	Global	Fader 3	CC#	CC#90	Global

Label	Type	Message	MIDI Channel		Label	Type	Message	MIDI Channel
Fader 4	CC#	CC#98	Global		Scroll	CC#	CC#108	Global
Fader 5	CC#	CC#99	Global		Zoom	CC#	CC#109	Global
Fader 6	CC#	CC#100	Global		Master	CC#	CC#110	Global
Fader 7	CC#	CC#101	Global		Marker	CC#	CC#111	Global
Fader 8	CC#	CC#102	Global		Nudge	CC#	CC#112	Global
Undo	CC#	CC#103	Global		Bank	CC#	CC#113	Global
Save	CC#	CC#104	Global		Channel	CC#	CC#114	Global
Cancel	CC#	CC#105	Global		Jog Wheel Rotate	CC#	CC#115	Global
Enter	CC#	CC#106	Global		Jog Wheel Switch	CC#	CC#116	Global
Cursor	CC#	CC#107	Global		Cycle	CC#	CC#117	Global

www.midiplus.com